

User Manual

ITB-100HD SP User Manual

iPASS BLACK

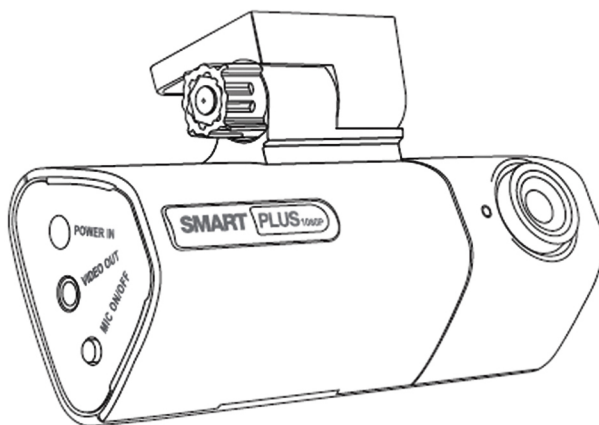

Vehicle Driving Recorder

ITRONICS

<Warranty & Scope of Liability of Video Recording>

- This product is supplementary device to bring a driver an awareness for safe driving and accident prevention, and reference about the circumstance of an accident. So, this product and it's recorded data can not be used to legally judge any party's liability of the accident.
- If the level of impact is so light even in the case of an accident, the impact sensor may not recognize it and fails to sort out the data as event file automatically. In this case, press the event button manually.
- The manufacturer shall not be liable for any damages due to the loss of data or any other malfunction occurred by the use of this product.

Table of contents

- Main features	02
- Safety instruction Warning	04
- Safety instruction - Caution	05
- Attention to SD memory card	06
- Attention to GPS	07
- Components	08
- Name of the product details	09
- Installation	10
- How to connect the Power(when using Uninterrupted-Power Cable)	12
- Disassembling the product from the Mounting Cradle	13
- Operation of the product	14
- Operation of Auto Parking Mode	15
- Installation of the PC player	17
- How to play the video	19
- Function keys in the PC player	23
- File management in the PC player	25
- How to change the user setting	27
- How to manage the recorded files	29
- How to update the product firmware	33
- How to format the SD memory card	35
- Setting Audio Recording On/Off	38
- Watching Live Video	39
- Product specifications	40

Main features

iPASS  BLACK

1. This Product records vivid quality of image with 16 :9 ratio of FULL HD (1920 x 1080) ultra high resolution at seamless 30 frame per second.
2. 2M pixel image sensor provides a more vivid images and diagonal 144 degree range of front angle will be compressed the wide angle of driving images into continuous video recording by H.264 high efficiency compression type 144 degree wide range.
3. Built-in GPS records the driving speed and display it in the PC player. It records the driving coordinates also and match it to the PC map.
4. When auto parking mode is activated, all-times recoding feature is ceased to avoid the long-term recording of unnecessary video while parking and the device will record for 60 seconds after of the event only when the device is sensing the shock on the vehicle and/or the motion of objects.
5. Built-In Super Capacitor for Instant Power Back-Up will help to complete the recording safely when the vehicle's electricity power is shut off due to any accidents like crashing.
6. When impact of collision, lightning acceleration or sudden brake is detected by the built- in impact sensor, the recorded data is marked as event file and stored in SD memory card automatically.
7. 3-axis log-in data captured by the built-in impact sensor is also recorded and a driver can see and analyze it in the PC player.

Main features

8. When the memory capacity of SD card has been filled, the latest data overwrite the older files and continues to record.
9. The audio (in-vehicle sound or noise of collision) is also recorded along with video data and playback in the PC player. In order to protect privacy , the audio recording can be also turned off in the PC player. (Korean Voice)
10. The data stored in the SD memory card can be played back easily at the computer using the iPASS BLACK PC player program.
11. As the recorded video will be saved as MP4 file type, the file can be played on any multimedia player of your personal computer.
12. Connecting Video out cable, watch the real-time live driving video recorded via Navigation or Monitor Screen.
13. Compact and contemporary design, and luxury SF coating on the product is harmonized with vehicle interior.
14. The security of a built-in LED high brightness, excellent visibility day and night, and can be used as a warning lamp on the long-term parking outside of the vehicle, you can easily the status of identify
15. The management of the SD memory card, built-in guide function, auto-format cycle, a certain amount of time (first, third Monday PM7: 00 to 7:30) to format the automatic voice prompts are used efficiently.

Safety instruction - Warning

iPASS BLACK



Warning

1. Do not try to operate the product when driving.
2. Do not disassemble, repair or modify the product. This void the warranty and the manufacturer takes no responsibility for the damage or problems to the product.
3. Do not clean the product with water or volatile solvents. This may cause the damage, fire or electrical shock to the product.
4. Use only genuine parts or accessories supplied and recommended by the manufacturer. If not, this may cause the damage or problems to the product.
5. Ensure to connect the product into stable power source in a vehicle. (DC12~24V).
6. If the product is connected to the battery of the vehicle at all times, please check the battery status regularly in order to avoid the electric discharge.
7. Do not place the product inside of a vehicle for a long time especially in the summer or winter season. This may cause the damage or problems to the product.

Safety instruction- Caution

iPASS BLACK



Warning

1. Please remove any excessive window tinting or obstacles of windshields. This may cause poor recording quality.
2. Please clean the lens of camera regularly.
3. If you need to re-install or change the location of the product, please ensure of the direction and angle of the camera lens for the proper recording position and confirm its recording status on playback.
4. Make a routine check on the position and angle of the camera lens. Especially check these items after driving on wild road or no use for a long time.
5. Recording quality is affected by lighting condition and may be poor or distorted under the sudden change of brightness level (ex : right after passing through the tunnel), no light in the night or against the light.
6. If the product is broken by huge impact like accident or disconnected from power source, it may stop proper operation.

Attention to SD memory card

1. Check the SD Memory card regularly in order for its normal and right operation.
2. Do not remove the power source or pull out the SD Memory card from the product when recording the data into the SD Memory card. This may cause the loss of data and damage to the SD Memory card.
3. Do not disassemble, repair or modify the SD Memory card. This may cause the loss of data and damage to the SD Memory card.
4. Please keep the SD Memory card into the hard case if you need to carry it alone for a long time.
5. Please use recommended SD Memory cards by the manufacturer. If not, this cause the loss of data or damage to the product.
6. Generally, a SD Memory card has limited lifetime and may be unable to store new data after certain period of time. In such case, please purchase new SD Memory card and replace the old one.
7. Please back up any important data in other storage device like hard disk drive, CD and so on.

Attention to GPS

1. A certain amount of time (minimum 5 minutes to maximum 30 minutes) may take until the GPS reception starts. This is the processing time of the GPS receiver to communicate with GPS satellites floating in the sky and may vary depending on weather condition and surrounding circumstances.
2. Even though the GPS reception signal is unstable, it is nothing to do with the basic function of the product and you can continue to record normally.
3. Please make sure to keep the GPS receiver fully exposed through the windshield and avoid to install the product to any position like tinted part of windshield.
4. If the camera lens tilts to backward for in-vehicle recording, the GPS reception may become poor. (The built-in GPS receiver faces down to the ground and may be unstable to communicate with GPS satellite.) Please revert back the direction of camera lens to the front after in-vehicle recording.
5. Do not use with other products that generate electromagnetic waves. This may interfere with a GPS and reduce the performance of GPS reception.

Components

iPASS BLACK

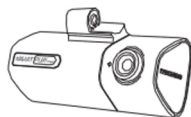

Main unit



Mounting Cradle



Adhesive tape
(spare)



SD memory card



SD card reader



Power cable



User manual



Cable holder



Uninterrupted-Power Cable
(Option)



Video Out Cable
(Option)

Name of the product details

iPASS BLACK

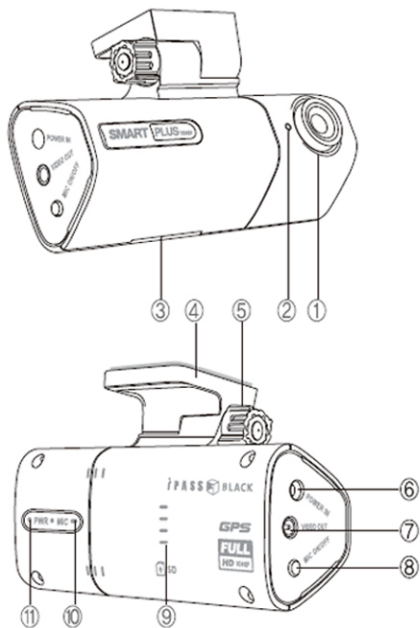

- ① Camera Lens
- ② Parking mode LED indicator
- ③ SD memory card slot
- ④ Mounting cradle
- ⑤ Cradle connection knob
- ⑥ Power connection port
- ⑦ Video out port
- ⑧ MIC on/off button
(also SD card format button)
- ⑨ Speaker
- ⑩ MIC Hole
- ⑪ Power LED Indicator
(Indicating Power Connection, Recording,
GPS Signal and Voice Recording Status)

Installation

iPASS BLACK



1. Clean the windshield where to place the product

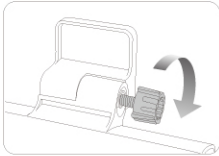

2. As shown in the picture, click the mounting cradle at the top of the product with Cradle Connecting Knob.



3. Remove the protection film of adhesive tape on the cradle and adhere it on the windshield with aligning the camera lens to the front direction.

- Tip : Please avoid adhering the product from any position where to block driver's view angle as well as where the camera lens is blocked by any objects to record front view.

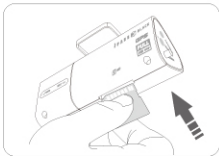

4. As shown in the picture, after confirming front and reverse side of SD Memory Card, insert and push the SD Memory Card into the slot on the bottom of the product.

Installation – Front Camera

iPASS  BLACK

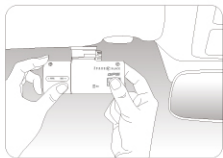

5. Align the direction of camera lens to the front.

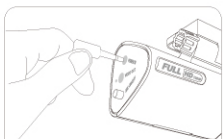

6. Connect the power cable and put into the cigarette lighter jack of the vehicle.

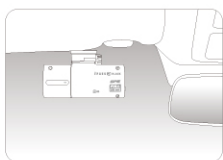

7. Arrange the cable with cable holders.
The installation is completed.

How to connect Power (when using Uninterrupted-Power Cable)

i P A S S BLACK

This product is available to be connected with Uninterrupted-Power Cable (UPC) for using the product as a surveillance camera when the vehicle engine is stopped. However, when you connect UPC, you are highly recommended to use our authentic UPC which has battery protection circuit in order to prevent the vehicle battery from discharging.



1. Open fuse box inside of the vehicle and, by using electric testing device, find the fuse which the power is supplied even while the key-off status of the vehicle. (For example, emergency flasher lights, interior lights and door lights etc.)

- Caution : UPC can be connected only when the voltage of vehicle power is 12V. Check Vehicle Voltage first by using such as electric testing device.

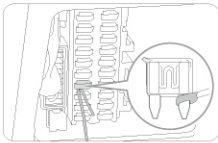

2. Pull out the fuse and connect one leg of the fuse with "+" end (red color) of UPC and insert back into original position



3. Connect "-" end (black color) of UPC to the any metal part of the vehicle. If there is no screw attached to the vehicle, you must to screw one on the vehicle.

- Note : Power is not coming in case you connect to plastic part like dash board other than metal part.

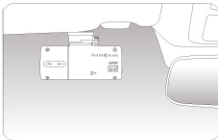

4. Make sure the product is working properly after the vehicle engine is started and then arrange and hide the cable connected to the product.

- Note : When UPC is connected, please manage SD Memory Card more thoroughly. (Recommended Number of Formatting : More than once a week)

Disassembling the product from the Mounting Cradle

iPASS BLACK

It is possible to assemble and disassemble the main unit with the cradle due to both are fixed by the fixing knob. Accordingly, please disassemble the main unit from the cradle when you need a repair service and/or to prevent the main unit from long-time exposure to direct sunlight

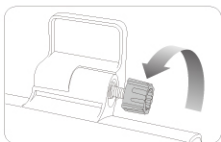

1. Rotate the knob in a counterclockwise direction until it is completely loosen.

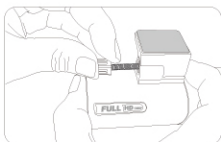

2. Remove the knob and detach the main unit from the cradle.

• Caution : Please make sure not to lost the knob.

Operation of the product

iPASS BLACK

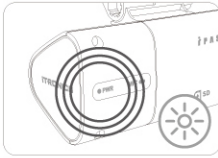

1. Turn on the power of a vehicle, the POWER LED turns on. The POWER LED also indicates the status of the GPS connection and it will blink with 2 seconds interval and stop to blink once the GPS is successfully connected.

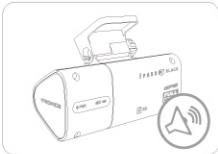

2. The product status LED display lights up and starts recording video after 15 seconds after a voice guidance (Korean).
Voice prompts until the video will not be recorded.

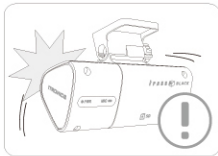

3. When impact of collision, lightning acceleration or sudden brake is detected by the built-in impact sensor, the POWER LED blinks three times and the recorded data is stored in SD memory card as event file.

- Note : In case the Shock-Sensing Sound Alarm is set to ON at User Setting, 2-scale beep tone (beep-beep) will sound with LED indication and save as Event Image. However, in order to prevent malfunction of 3-axis acceleration sensor, if the Event happens within 10 seconds after Alarm tone sounds, Alarm tone won't sound but just LED blinks 3 times and record as Event Image.

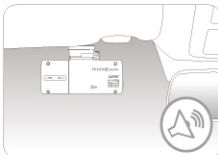

4. The end of the video recording, video files approximately 5~10 seconds after the end of the driving of the vehicle when the power is turned off after cleanup voice guidance.
Never remove the SD memory card before the end prompts.

Operation of Auto Parking Mode

iPASS BLACK

Auto Parking Mode Switching function is built in this device and, in case of long-term parking, you can switch or release auto parking mode by built-in 3-axis acceleration sensor. In case of recording while parking, this device records only when sensing shock or motion for higher efficiency of SD Memory Card.

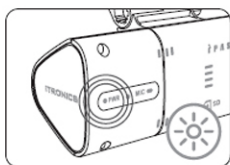

1. In order to switch to auto parking mode, the device must be connected to electric power source of the vehicle. After connecting, make sure the power of this device is still turned on even after the power of vehicle is turned off. Please refer to page 12 for how to connect uninterrupted power cable.

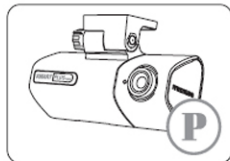

2. This device is automatically sensing and switching to auto parking mode when the vehicle doesn't move for parking or stopping for more than 5 minutes subject to the device setting is set to auto parking mode.

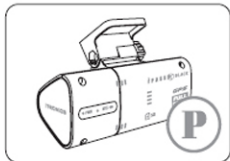

3. When entering auto parking mode, the recording starts after the event happens as per event situation set at the setting menu and the recorded files are stored with "pmr_date.avi" format. In PC Player program, you can easily recognize the file by icon marked at the front of the file name.

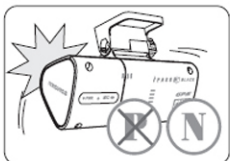

4. If the shock and/or the motion of vehicle is detected, the device will automatically release auto parking mode and return back to normal recording mode.

• **Note :** Recording at Parking Mode is working only when shock or motion is detected, however, it may not be working if shock or motion is weak. Also, please be noted that the recording can be resumed by the surrounding noises (close to factory, street side).

Operation of Auto Parking Mode

• Table of error beeps

Type of beep	Root cause	Trouble shooting
Please put the SD card (Korean)	No SD memory card detected in the SD memory card slot	Insert the SD memory card
Inspection is the SD card. (Korean)	SD memory card related error	Format the SD memory card or replace with new one
1 scales beep	Error in the time management of the main unit	Contact the local service provider

• Note

The notification, and if the setting is set to "Off" voice guidance, voice only guidance. Format descriptions, the update is still in progress, error descriptions sound only set up voice prompts and voice prompts will guide you.(Korean)

Installation of the PC player

You can play back the recorded video and audio data on the PC via PC player supplied by the manufacturer. This PC player program is most optimized to run in Windows XP, Windows Vista, and Windows 7 (32 bits).

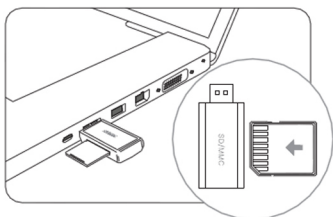

1. Pull out the SD memory card from the main unit and insert it into the memory card reader as shown on the left picture. Then put the memory card reader into the USB port of the PC.



2. Search the USB disc and double click the installer file named by ITB HD BLACK-BOX PC Player Setup.exe.

Installation of the PC player

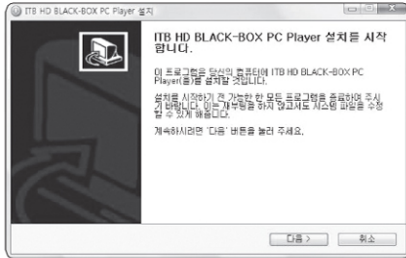

3. Click the start button and the installation will start.

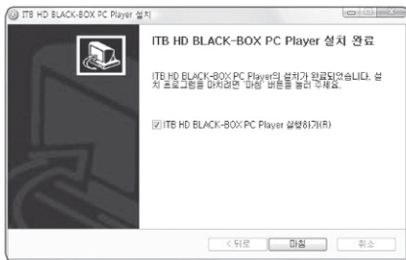

4. If the installation is finished, click the finish button.

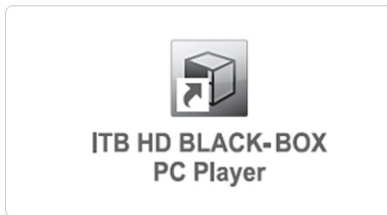

5. If shortcut icon appears on desktop screen, the installation is completed.

How to play the Video

iPASS BLACK

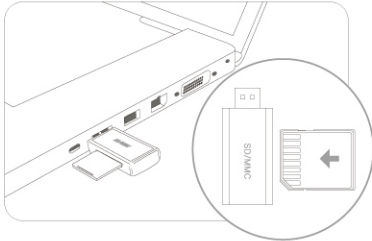

1. Pull out the SD memory card from the main unit and insert it into the memory card reader as shown on the left picture. Then put the memory card reader into the USB port of the PC.



**ITB HD BLACK-BOX
PC Player**

2. Click the shortcut icon of the PC player.



3. Then, the PC player pops up.

How to play the Video

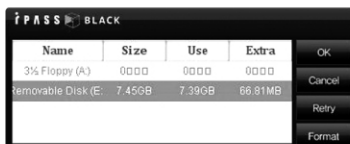

4. Select the appropriate SD memory card and click the OK button.

All	Date	Name
N	20111207_191703	2011-12-07 19:17:03
N	20111207_191803	2011-12-07 19:18:03
N	20111207_191903	2011-12-07 19:19:03
E	20111207_192003	2011-12-07 19:20:03
N	20111207_192103	2011-12-07 19:21:03
N	20111207_192203	2011-12-07 19:22:03

5. All files in the SD memory card will be loaded on the right window and playback one by one in the sequential order of recording date and time (older comes first).

All	Date	Name
N	20111207_191703	2011-12-07 19:17:03
N	20111207_191803	2011-12-07 19:18:03
N	20111207_191903	2011-12-07 19:19:03
E	20111207_192003	2011-12-07 19:20:03
N	20111207_192103	2011-12-07 19:21:03
N	20111207_192203	2011-12-07 19:22:03

6. Just press the file directly if you want to move another file.

① All	② Date	③ Name
N	20111207_191903	2011-12-07 19:19:03
E	20111207_192003	2011-12-07 19:20:03
N	20111207_192103	2011-12-07 19:21:03
N	20111207_192203	2011-12-07 19:22:03

• You can sort the Recorded Files by clicking List Menu in the top part of file list.

- ① Align the Files by 4 types as per recorded status.
(Status: All/Shock/Parking/Normal Mode)
- ② Align the Files by Ascending or Descending Order based on File Name
- ③ Align the Files by Ascending or Descending Order based on the Date

How to play the Video



7. The graph shown under the playback screen means the degree of X axis (front and back), Y axis (left and right), and Z axis (up and down) impacts when an event occurs.

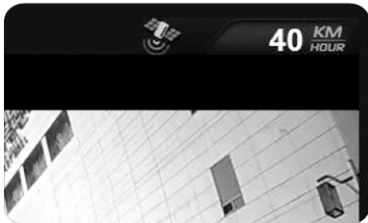

8. The driving speed and GPS status displays on the top of the playback screen.



9. Built-in GPS records the driving coordinates and match it to the internet PC map. Please note that the PC must be connected to Internet in order to use internet PC map service.

- PC map window can be closed or open pressing the  icon.

How to play the Video

- You can move, select, play, delete the recorded files by PC Keyboard operation in the File List Window of PC Player and please refer to the below for more details.

- ① "Shift" Key + File Selection : Select the continuous group of files of the list.
- ② "Ctrl" Key + File Selection : Select the multiple individual files of the list.
- ③ "Up" or "Down" Arrow Key : Move in the file list
- ④ "Left" or "Right" Arrow Key : Fast Rewind or Forward by 10 seconds interval of the played file.
- ⑤ "Page Up" or "Page Down" Key : Play the file before or after the currently playing file
- ⑥ "Enter" Key : Play the selected file or resume the played file from the very beginning
- ⑦ "Delete" Key : Delete the selected file

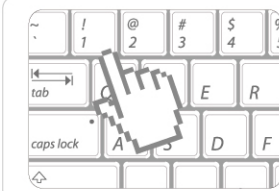

- You can play the selected view what you want to see between the simultaneously recorded front and review view video.

Numeric "1" Key : Play the front view only

Numeric "2" Key : Play the both front and rear view

Numeric "3" key : Play the review only

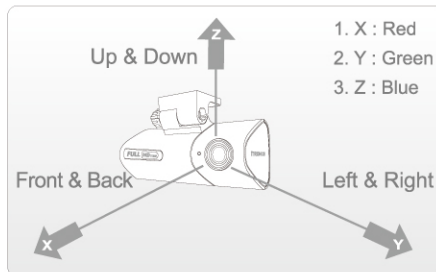

- If the level of impact is so light even in the case of an accident, the impact sensor may not recognize it and fails to sort out the data as event file automatically. In this case, press the evnt button manually.

Function keys in the PC player

DATE 2012/10/16 TIME 08:31:32

25 KM/HOUR









방향	이름	날짜
E	2012-10-16_081730	2012-10-15 09:17:30
N	2012-10-16_081830	2012-10-15 09:18:30
N	2012-10-16_081930	2012-10-15 09:19:30
N	2012-10-16_082030	2012-10-15 09:20:30
E	2012-10-16_082130	2012-10-15 09:21:30
E	2012-10-16_082230	2012-10-15 09:22:30
E	2012-10-16_082330	2012-10-15 09:23:30
E	2012-10-16_082430	2012-10-15 09:24:30
E	2012-10-16_082530	2012-10-15 09:25:30
E	2012-10-16_082630	2012-10-15 09:26:30
N	2012-10-16_082730	2012-10-15 09:27:30
N	2012-10-16_082830	2012-10-15 09:28:30
E	2012-10-16_082930	2012-10-15 09:29:30
N	2012-10-16_083030	2012-10-15 09:30:30
N	2012-10-16_083130	2012-10-15 09:31:30
N	2012-10-16_083230	2012-10-15 09:32:30
N	2012-10-16_083330	2012-10-15 09:33:30
N	2012-10-16_083430	2012-10-15 09:34:30
N	2012-10-16_083530	2012-10-15 09:35:30
N	2012-10-16_083630	2012-10-15 09:36:30
N	2012-10-16_083730	2012-10-15 09:37:30

ASEEN 아신
우편·물류 서비스 전문

TOTAL LOGISTICS & MARKET

1.0X

Function keys in the PC player

Icon	Description
	Go to previous or next file
	Jump to 10 seconds previous or after image
	Play
	Pause
	Video brightness control
	Night Vision (*)
	180 degree rotate for reversed images
	Image capture
1.0X	Play speed control
	Audio volume control

*** What is Night Vision ?**

In dim illumination circumstance, Night Vision can help to play the video with more vivid quality to see the surroundings clearly by amplifying the light of recorded video as much as possible.







File management in the PC player

The screenshot displays the iPASS BLACK PC player interface. The main window shows a dashcam video feed from a vehicle's perspective. The video shows a street scene with several cars and a large white van on the right. The van has the text "ASEEN 아신" and "TOTAL LOGISTICS & MARKET" on its side. The video player includes a date and time overlay: "DATE 2012/10/16 TIME 08:31:32". At the top right of the video area, it shows "25 KM/HOUR". Below the video feed is a playback control bar with standard media controls and a "1.0X" speed indicator.

On the right side of the interface, there is a data table with the following columns: "방향" (Direction), "이름" (Name), and "날짜" (Date). The table contains a list of data points, each with a direction (E or N), a name (e.g., 2012-10-16_081730), and a date (2012-10-15 09:17:30). The table is currently showing 25 records.

Below the table is a map view showing the vehicle's current location on a street grid. The map includes labels for "대안산" and "대안산" and a small icon representing the vehicle's position.

File management in the PC player

Button	Function	Description
	Select SD Memory Card	Select SD Memory Card which saves Recorded Image to play or to format
	Read Recorded Files	Read Recorded Images saved in PC
	Delete	Delete the selected Recorded Images
	Copy	Copy the selected Images to separate folder (folder name: HD- BLACKBOX) *
	Save Event Image	Save all Event-marked Images to separate folder (folder name: HD-BLACKBOX) *
	User Setting	Change the setting value and please refer to the next page for more details.

* HD-BLACKBOX folder will be created on Desktop screen of PC.

How to change the user settings

Setting Driving Mode



Setting Parking Mode



- ① Exclusive PC Player Version : Displays the version of exclusive PC player.
 - ② Recording Mode : Set the Recording Resolution and number of recording frames per a second.
 - ③ Brightness : Set the brightness of Recording Image.
 - ④ Shock-sensitivity while driving : Set the sensitivity of 3-axis acceleration sensor while driving. In case of setting to OFF, Event file (E) will not be recorded while driving and you can not set the ratio of "Event" file (E) at Deletion by File Type menu.
 - ⑤ Speed Display on Image : It will display the speed of vehicle at the time of recording and you can see the speed when playing the image on the other media player other than exclusive PC player. Speed display will be shown at the left upper part of image since after GPS signal is received and, in case GPS signal is not received in underground parking lot etc., it will show as "----".
 - ⑥ Voice guidance : ON/OFF Setting.
 - ⑦ Volume for voice guidance : You can adjust the volume of voice guidance.
- ① Parking Mode : Set Auto Parking Mode when parking and also set Event recording type when setting Auto Parking Mode. In case of setting to OFF, it will not enter to Parking Mode even while parking and you can not set the ratio of "Parking" file (P) at Deletion by File Type menu. (Shock : In case the impact on the vehicle, Motion: Motion is sensed by Camera)
 - ② Shock Sensitivity while Parking : Set the sensitivity of 3-axis acceleration sensor while Parking Mode Recording and, although the setting value is same as the one of shock sensitivity while driving, shock sensitivity while parking works much sensitive.
 - ③ Setting Motion Sensitivity : Set the motion sensitivity while Parking Mode Recording.

How to change the user settings

General Setting



- ① Shock-Sensing Sound Alarm : Set the Sound Alarm announcement when recording Event File by impact sensing on the vehicle. However, you can not use this function in case the shock sensing menu while driving is set to OFF at Driving Setting Mode.
- ② File Deletion Type : Set the file deletion type of recorded images but you can not set this function in case both shock-sensing while driving and parking mode setting are set to "OFF". Please refer to page 34 ~ 35 for detailed way of recording. (You can adjust the ratio with computer mouse by clicking and moving the small circle on the straight line path.)
- ③ Time Zone : You can set the standard time zone of your area.
- ④ Firmware Version : Displays the firmware version of the product.

Recording Time Available per Setting (Actual recording Time may somewhat vary.)

Description	ITB-100HD SP					
	FULL HD(1920X1080)		HD(1280X720)		D1(720X480)	
Resolution						
Numbers of frames per second (fps)	30fps	15fps	30fps	15fps	30fps	15fps
Saving Recorded File (unit)	1 min.	2 min.	1 min.	2 min.	1 min.	2 min.
Recording Time Available (based on 8GB SD Memory Card)	2 Hrs 50 Min	4 Hrs 15 Min	3 Hrs 50 Min	5 Hrs 30 Min	7 Hrs 50 Min	12 Hrs 30 Min

How to manage the recorded files - PC Player

This product saves the image based on always-recording type. However, as per the circumstances at the time of image recording, it classifies by normal recording while driving/event recording while driving/event recording while parking and saves to memory allocation as per user setting values. In case of exceeding the allocated memory capacity, it deletes the images either from the oldest order or deletes all by the lump and then saves the newer images. Please refer to the below for more details.

1. Deletion by Time Order

It is the recording type, no matter what the circumstances at the time of recording (normal recording while driving /event recording while driving or parking mode), to delete the images from the oldest ones and saves new image in case the capacity of recorded images are exceeding the memory card capacity.

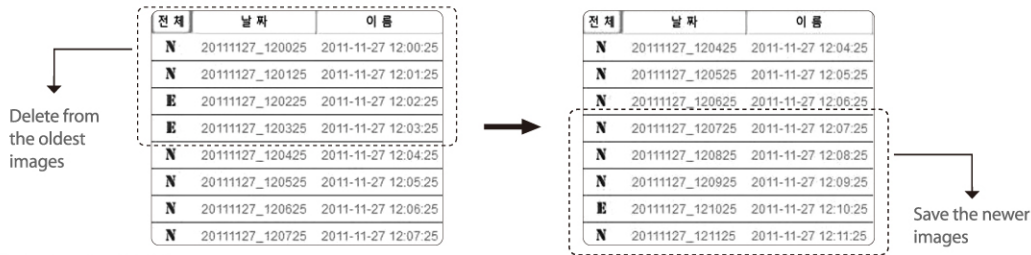

2. Deletion by File Type

Image files are saved based on time order as Normal Recording (N) and Event Recording File (E, P) and you can set the memory allocation capacity of each file types. In case of exceeding the allocated memory capacity, it deletes the images either from the oldest order or deletes all by the lump and then saves the newer images. However, you can not set the ratio of allocation space in case both shock-sensing while driving and parking mode settings are set to "OFF".

- ① Always : Setting the saving capacity for normal recording while driving file
- ② Event : Setting the saving capacity for event recording while driving file
- ③ Parking : Setting the saving capacity for event recording while parking mode file

How to manage the recorded files - PC Player

Deletion by File Type classifies and saves the recording files per each circumstances as per the ratio set at User Setting. Accordingly, in case the image saving ratio is changed by changing Shock-sensing while driving or Parking Mode setting from "OFF" to "ON" when the pre-set Recording Image Capacity per each circumstances are full, this product will delete by the lump from the oldest recorded images as per changed setting ratio to secure the memory space and resume the recording. However, in case you change the setting from "ON" to "OFF" in the shock-sensing while driving or parking mode, this product does not delete by the lump but delete sequentially the corresponding recorded file type first and records the newer images.



<Deletion the exceeding portion by the lump>

In case changing parking mode setting to "ON" and adjusting setting ratio, exceeding portion of 20% out of pre-set ratio of event file(50% → 30%) will be deleted by the lump from the oldest to secure the memory space and it will save the parking mode recording file.

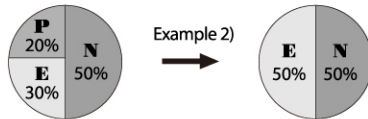

<Deletion the exceeding portion sequentially>

In case changing parking mode recording setting to "OFF", it does not delete by the lump but delete sequentially from the oldest parking file (P) to secure the memory space.

In case the event is happened within 5 seconds since the recording starts, the previous recorded file is event marked together in order to show the before-event situation. Also, in case the event is happened in 5 seconds prior to the recording ends, the post recorded file is event-marked in order to show the after-event situation.

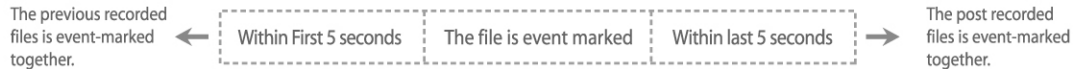

How to manage the recorded files - PC Player

This product saves the image based on always-recording type except parking mode. However, as per the circumstances at the time of image recording, it classifies by normal recording while driving/event recording while driving or while parking and saves to memory allocation as per user setting values. Recorded files are aligned by time order in Exclusive PC Player and the corresponding icons in front of file name help you to identify the file easily.

1. Exclusive PC Player

Oldest images are shown sequentially at the Exclusive PC Player File List Window as below, and the corresponding icons per recording circumstances identifies the files.

전체	파일 이름	날짜
N	20110423_123215	2011-04-23 12:32:15
N	20110423_123115	2011-04-23 12:31:15
N	20110423_122915	2011-04-23 12:30:15
N	20110423_122915	2011-04-23 12:29:15
N	20110423_122815	2011-04-23 12:28:15
E	20110423_092237	2011-04-23 09:22:37
P	20110423_091011	2011-04-23 09:10:11
P	20110423_085238	2011-04-23 08:52:38
P	20110423_083917	2011-04-23 08:39:17
P	20110423_082626	2011-04-23 08:26:26

- Recording File Type per Circumstances

N : Normal Recording Image File while Driving

E : Event Recording Image File while Driving

P : Event Recording Image File while Parking

- Saving Time Capacity Unit per Recording File

Max 1 Min. (But. Max 2 Min in case of 15 fps)

How to manage the recorded files - PC USB Disc

This product saves the image based on always-recording type except parking mode. However, as per the circumstances at the time of image recording, it classifies by normal recording while driving/event recording while driving or while parking and saves to memory allocation as per user setting values. Recorded files are saved as specific file type per recording circumstances as below.

1. PC Removable Disk

In case to see the recorded images at the PC removable disk, you can identify the files because it is saved as specific file type per recording circumstances as below.



- Recording File Type per Circumstances

Normal Recording File: rec_date.avi

Event File while Driving: evt_date.avi

Event File while Parking: pmr_date.avi

How to update the product firmware

The firmware of the product can be updated easily if any new firmware is released for the purpose of improvement and/or correction of the product firmware.

1. Download the new firmware from the web site of local service provider.



2. Unzip the file and you can find the file named " itb100spfw.bin " from unzipped folder.

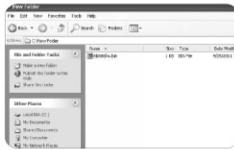

3. Pull out the SD memory card from the main unit and insert it into the memory card reader as shown on the left picture. Then put the memory card reader into the USB port of the PC.



4. The SD memory card will be detected as USB disc.



How to update the product firmware

iPASS BLACK



5. Please copy the file into the root directory of SD memory card.



6. After the SD card(complete copy) is inserted into the product, Connect the power supply. and, updates start voice guidance (Korean) is in progress. In progress, the update process to the "beep" sounds. And, after completing the update, then reboot and start recording.

- Please do not remove the SD memory card in the middle of firmware update. It may cause damage to the product.

Confirming Firmware Version

1. Please run Exclusive PC Player after connecting SD Memory Card with PC.
2. You can see the firmware version at the pop-up window when starting Exclusive PC Player and at General Setting of User Setting Menu.

How to format the SD memory card - method 1

Generally, a SD memory card has limited lifetime and may be unable to store new data after certain period of time. In order to extend its lifetime, we recommend you to format the SD memory card periodically. The recommendable format cycle is 2 times per week and the method of format is as follows.

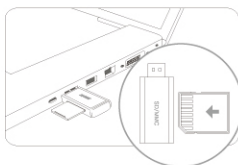

1. Connecting to your Personal Computer

Pull out the SD Memory Card from the main unit and insert it into the SD Memory Card Slot of your personal computer (If the SD Memory Card Slot is not exist in your personal computer, insert SD Memory Card into SD Memory Card Reader and connect the Reader to USB terminal of your personal computer) as shown on the left picture.



2. Playing PC Player Software

Run PC Player Software and click the SD memory Card icon in the bottom of software window.

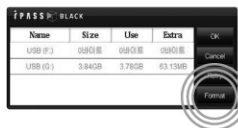

3. Formatting SD Memory Card

Choose SD Memory Card to be formatted and click Format button.

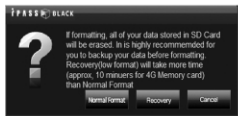

4. Setting SD Memory Card Format Type

Set the SD Memory Card Format Type. Please refer to the next page for more detailed explanation.

How to format the SD memory card - method 1

- Detailed Explanation on Format Type

- Normal Format : Except optimizing this product, it will format SD Memory Card as like formatting personal computer.
- Recovery : This is to initialize the whole memory of SD Memory Card (Low Format) and this way of formatting is useful if there is any error that can't be recovered by Normal Format. But, it will take more time (approx. 10 minutes for 4GB Memory Card) than Normal Format.

- Caution

In case you insert SD memory Card, which was formatted by windows Explorer software instead of using format menu of PC player, into the main unit, this Product will automatically reformat the sd memory card to make the product to be an optimal status. in case of reformatting, as all files stored in the SD memory Card will be removed, please do not store your personal data files in SD memory Card. However, if you format using format menu of PC Player software, automatic reformatting will not occur.

- Tips

1. Even though you do format using PC Player software, existing Set-Up menu related files, which you have set before, will remain unchanged.
2. Even though you do format using format menu of PC Player software, you can use same as before at your personal computer.

How to format the SD memory card - In the vehicle

iPASS BLACK

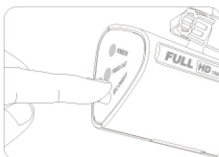

1. Press Mic On/Off Button for about 5 seconds.



2. When formatting start, beep alarm sounds and self-format function is working.

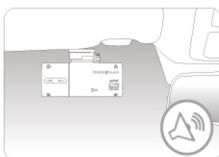

3. Upon completion of the SD memory card format, and automatically reboot after the voice guidance (Korean) to start recording.
Built-in ability to automatically format descriptions.
A guide format automatically when the voice of the
(first and third Monday, PM7:00 to 7:30).

• Note

- User Setting values are unchanged and will remain same as before even formatting.
- Existing folders generated will be automatically generated when the recording is started after SD Memory Card is inserted.

Setting Audio Recording On/Off

iPASS BLACK

As this product has built-in microphone, just in case of privacy invasion when recording voice of in-vehicle, you can easily change the setting of audio recording in the vehicle. For more details, please refer to the below.

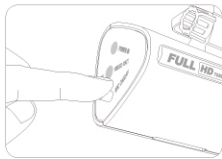

1. Press Microphone On/Off button short.

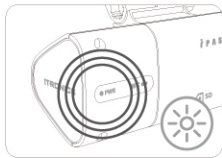

2. LED color indicates Voice Recording Status.

LED Color	Voice Recording Status
Red	On
Green	Off

Watching Live Video

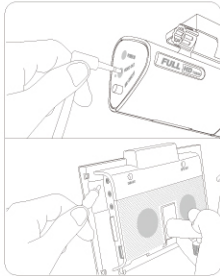

1. Connect AV cable between Video Output port of the main unit and Navigation/ Monitor which has AV Input port.

• Note : Navigation or Monitor must be NTSC compatible.

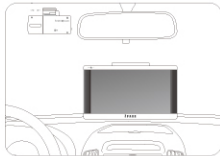

2. Check the live driving video which is real-time recording and adjust the camera angle and check if the video is properly recorded.

• Note : You can watch the video which the recording is progressed and can't watch the previous video which the recording was completed.

Specifications

iPASS  BLACK

Items		ITB-100HD SP
Camera	Type of sensor	CMOS
	Coverage / Pixels	Diagonal 144 degrees / 2Mil pixels
Recording	Data compression	H.264
	3 axis impact sensor	Built – in
	Resolution	FULL HD 1920x1080 / HD 1280x720 / D1 720x480
	Selectable fps	15,30 fps
	Audio Recording	YES (MIC inside)
Others	GPS	Inside
	Power input	12 ~ 24V
	Size	96.2 mm (W) x 40.4 mm(H)
	Weight	80 g
	Operating temperature	-20~ 70°

i P A S S

Level Up Tomorrow



ITRONICS

Vehicle Driving Recorder

ITRONICS